

Glasbearbeitung bei Verwendung als:

180° Außenwinkel-Verbinder DIN "RECHTS", Glas 8 mit 8

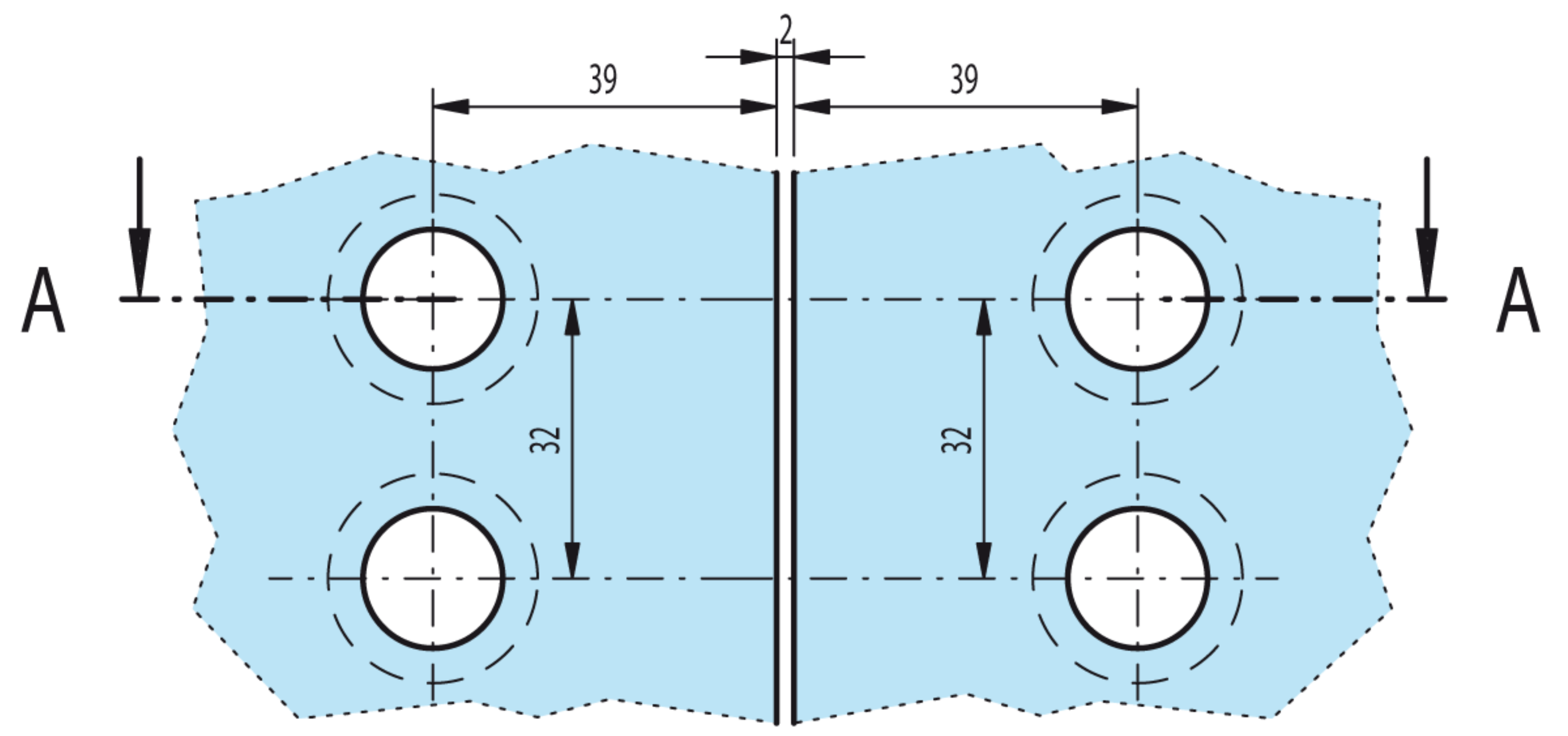

Festteilglas 2

Festteilglas 1

(Senkung = Innenseite)

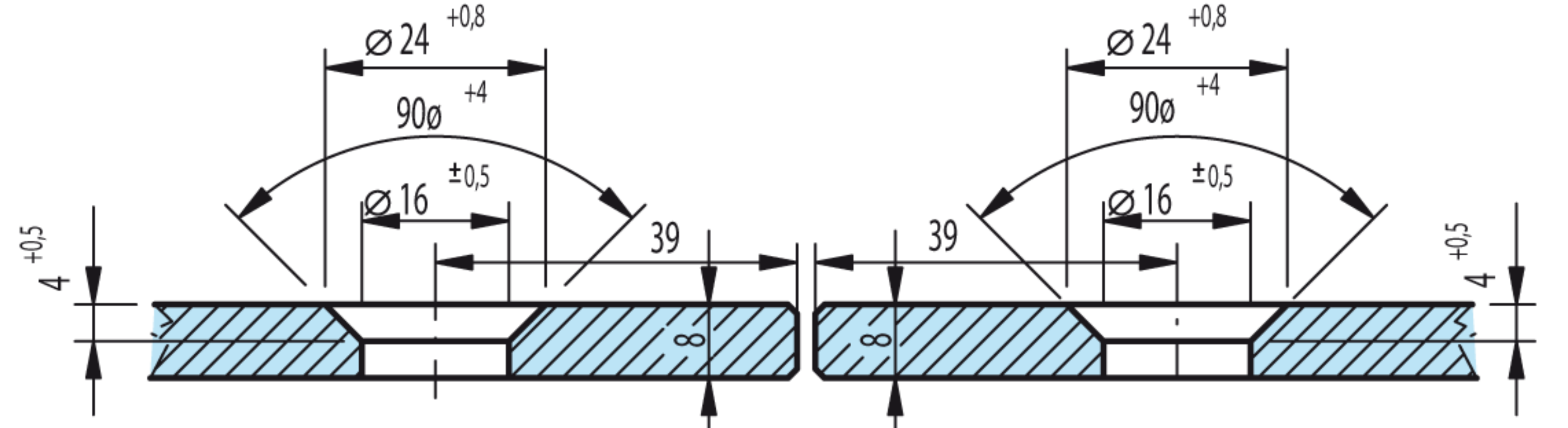

Schnitt: A-A (M1:1)

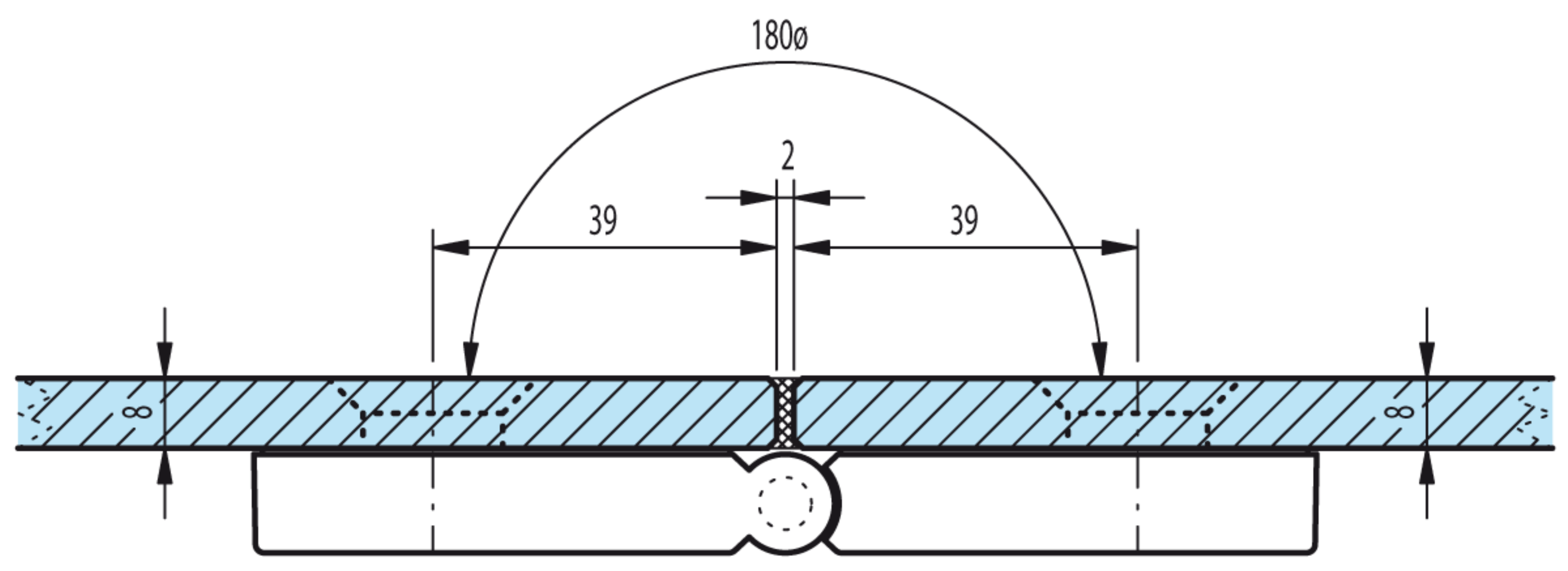

Festteil 2

Festteil 1

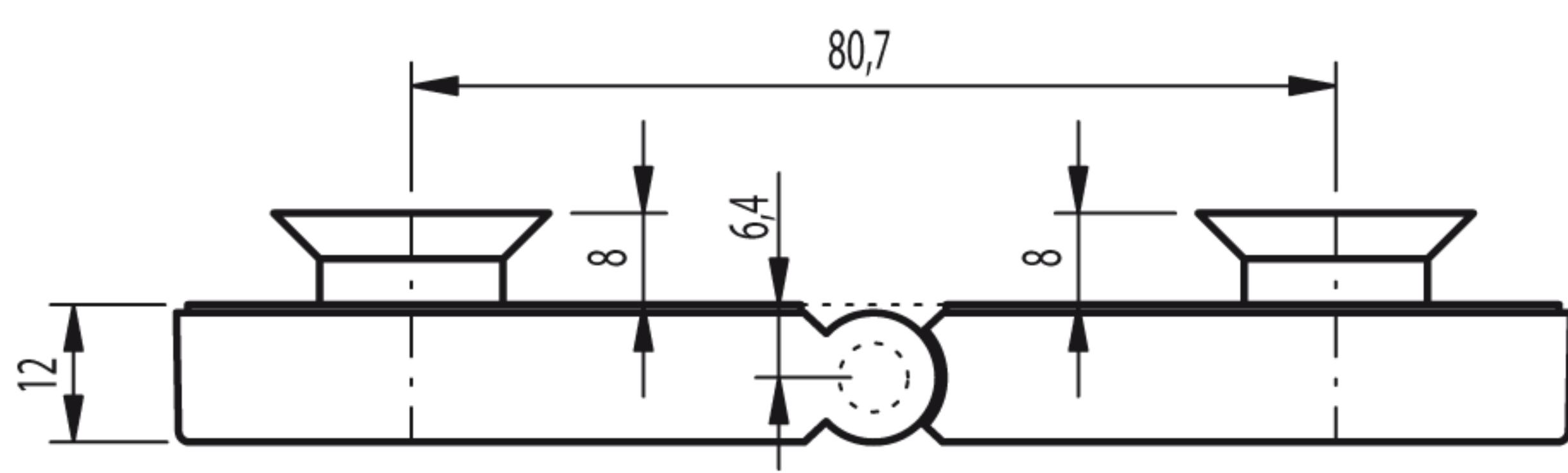
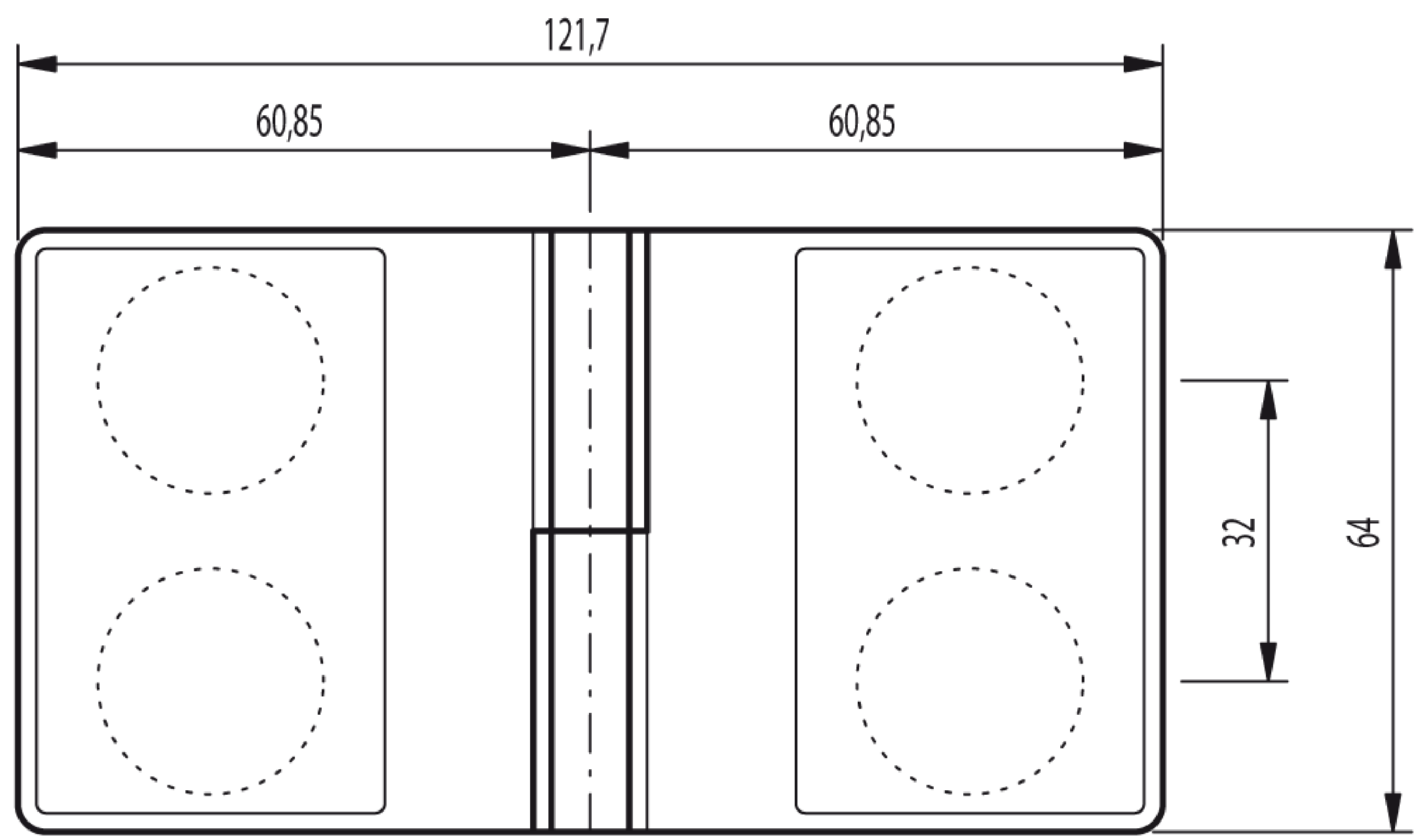

Art.-Nr.: 20 1058 12 XX 00