

Glasbearbeitung bei Verwendung als:

135ø Außenwinkel-Verbinder DIN "LINKS", Glas 8 mit 8

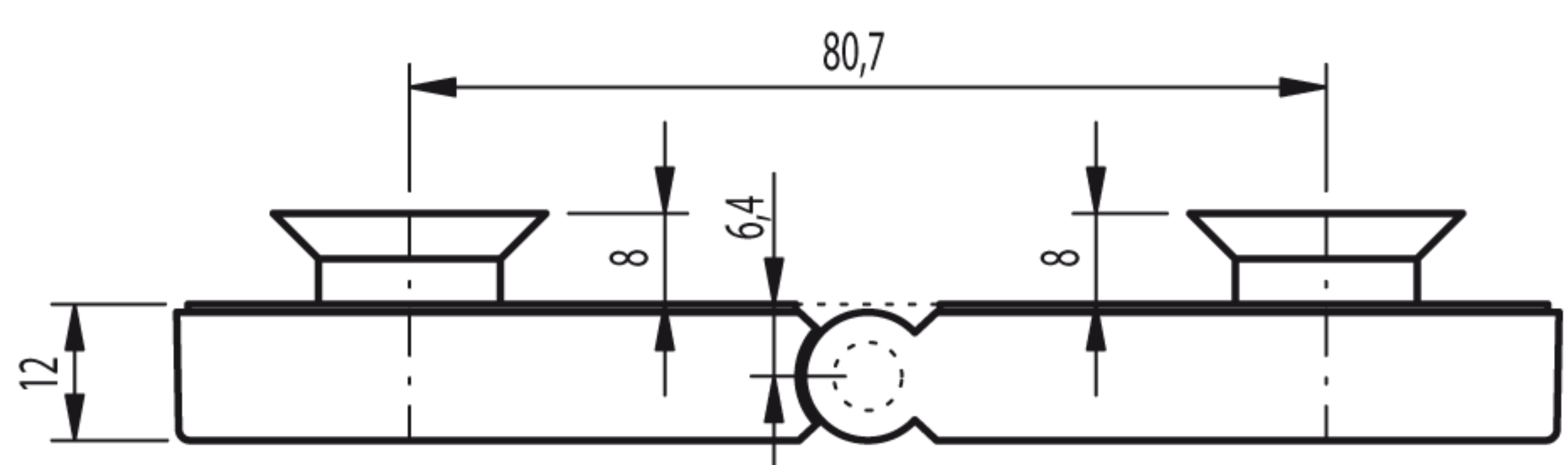

Art.-Nr.: 20 1057 12 XX 00

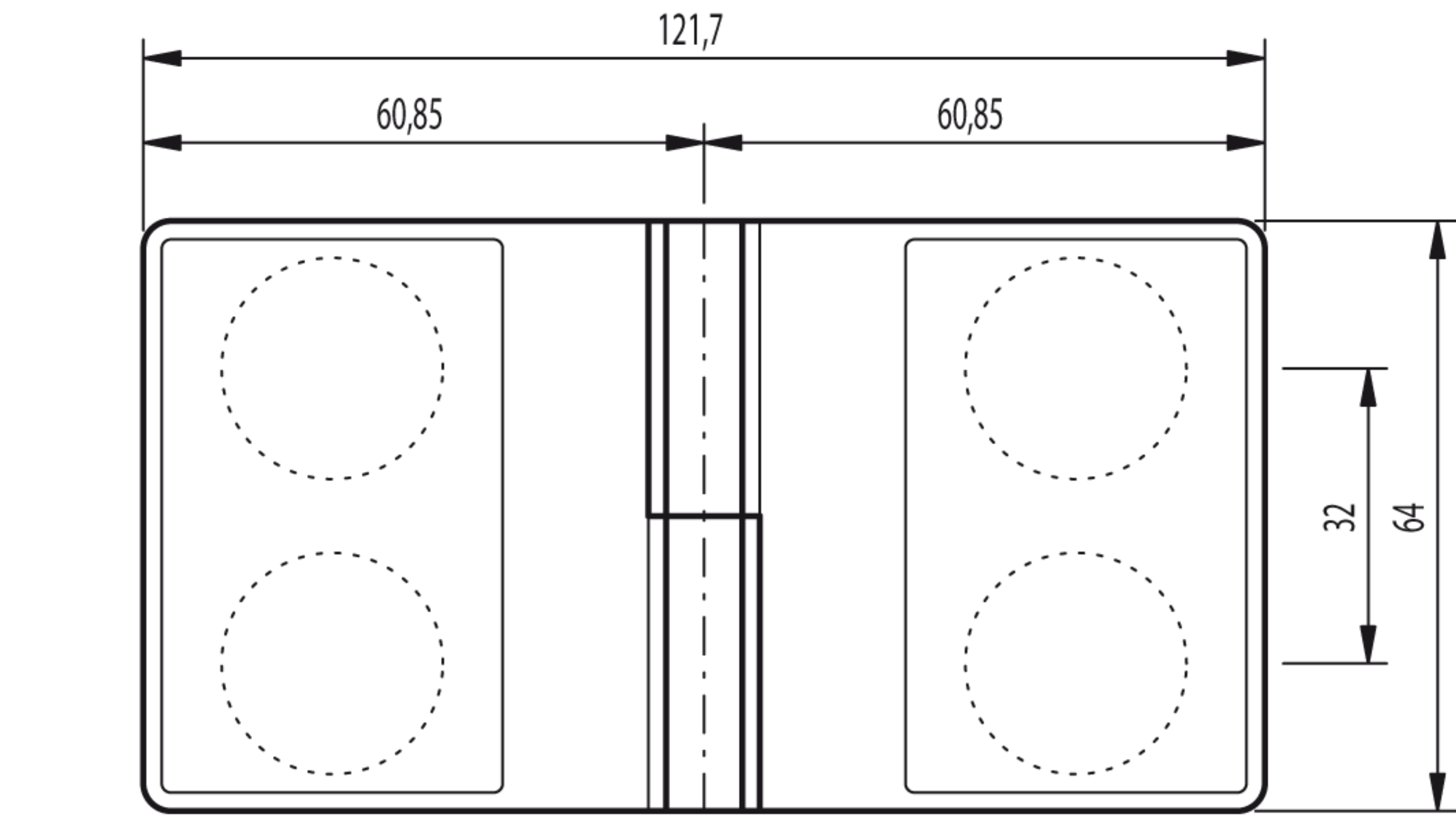
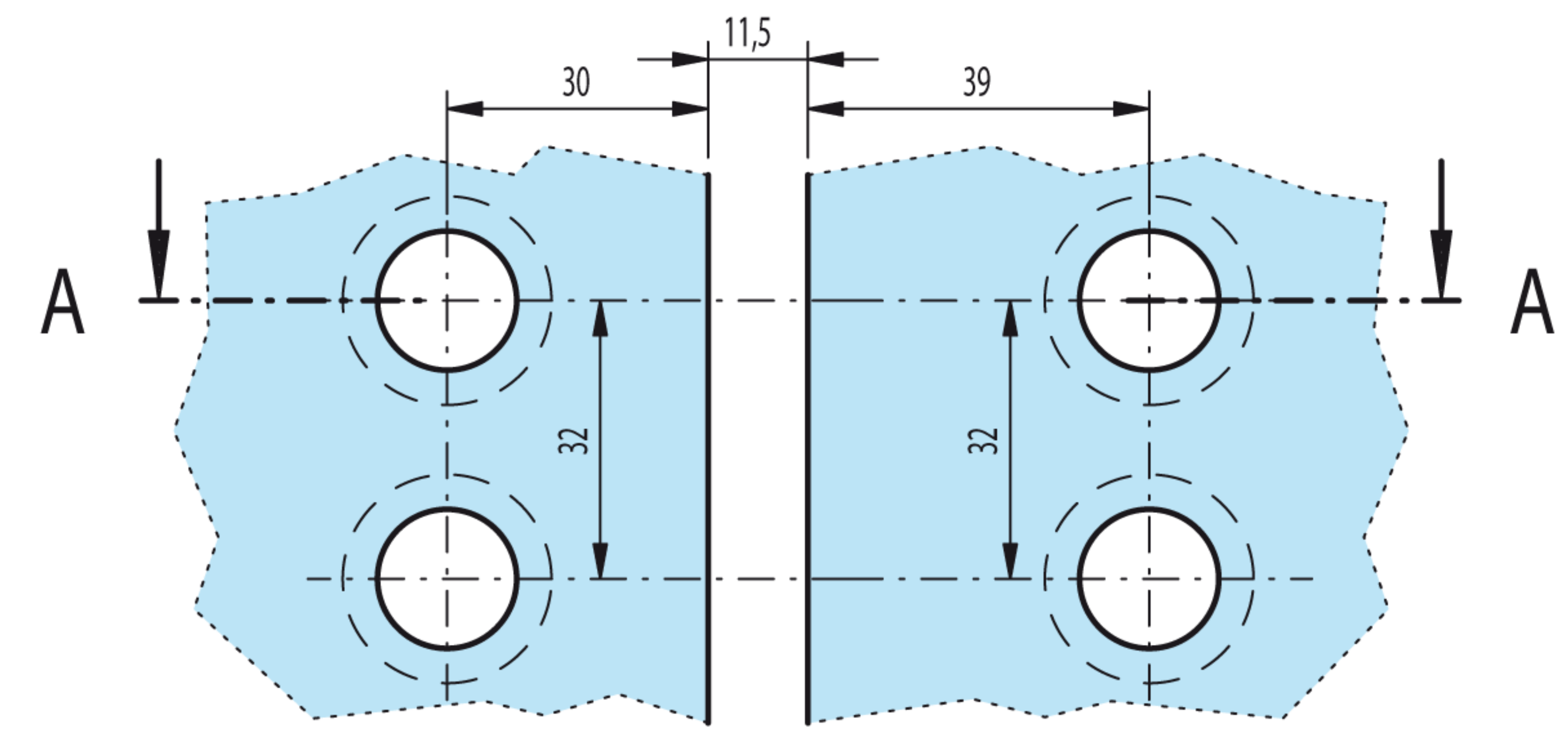

Festteilglas 1

Festteilglas 2

(Senkung = Innenseite)

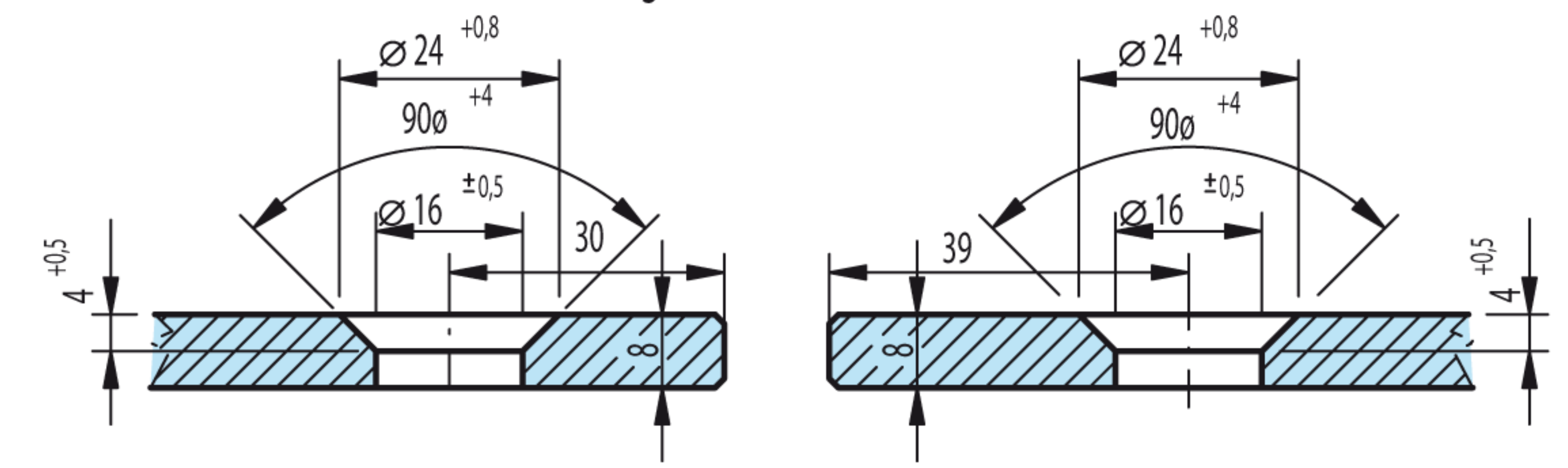

Schnitt: A-A (M1:1)

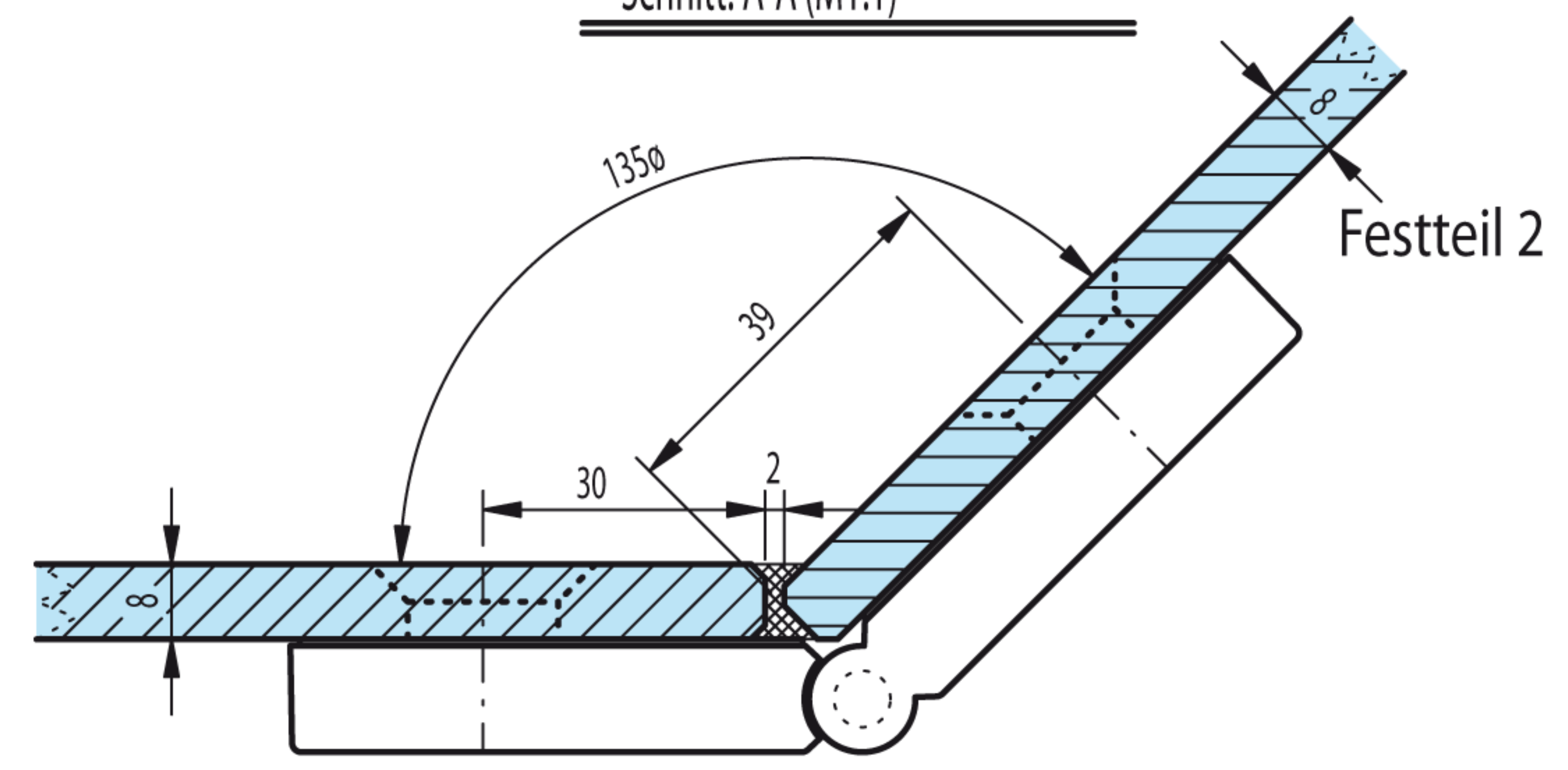

Festteil 1

Festteil 2