

Glasbearbeitung bei Verwendung als:

90° Außenwinkel-Verbinder DIN "RECHTS", Glas 6 mit 8

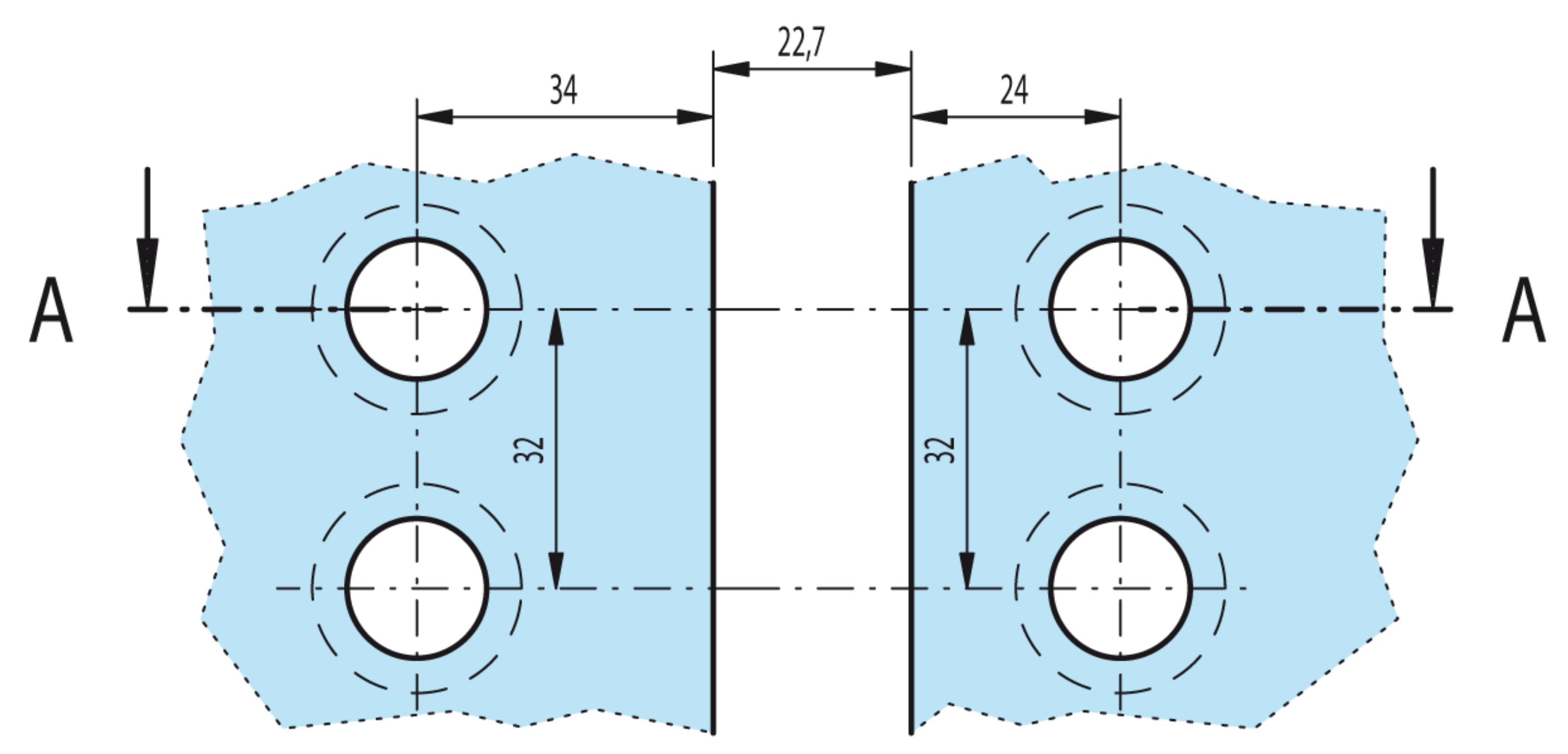

Festteilglas 2

Festteilglas 1

(Senkung = Innenseite)

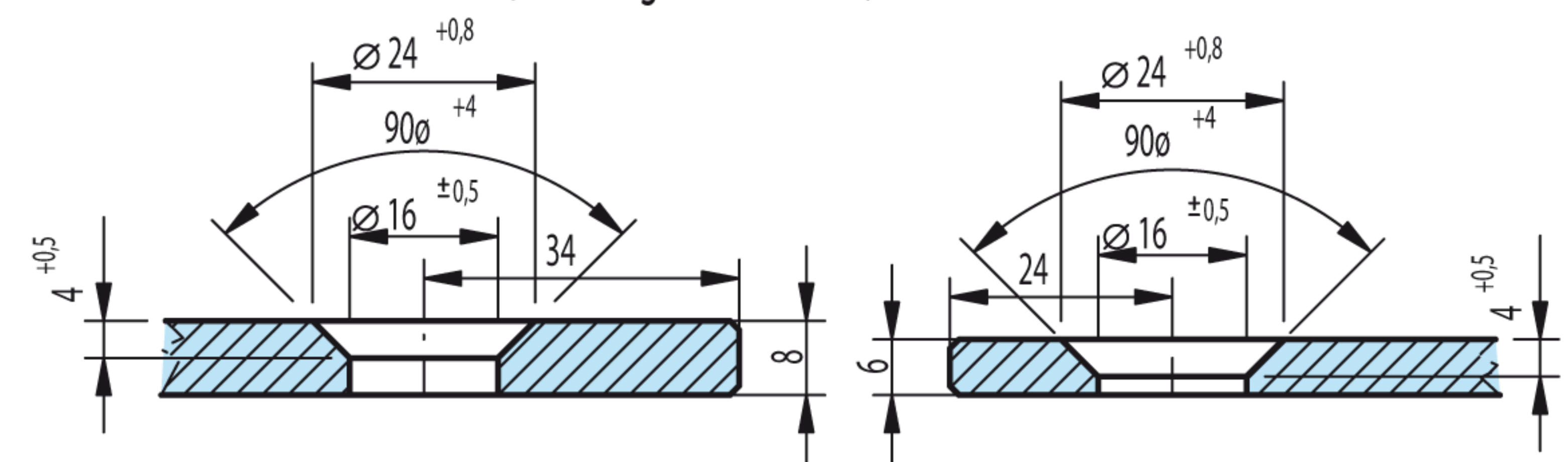

Schnitt: A-A (M1:1)

Festteil 2

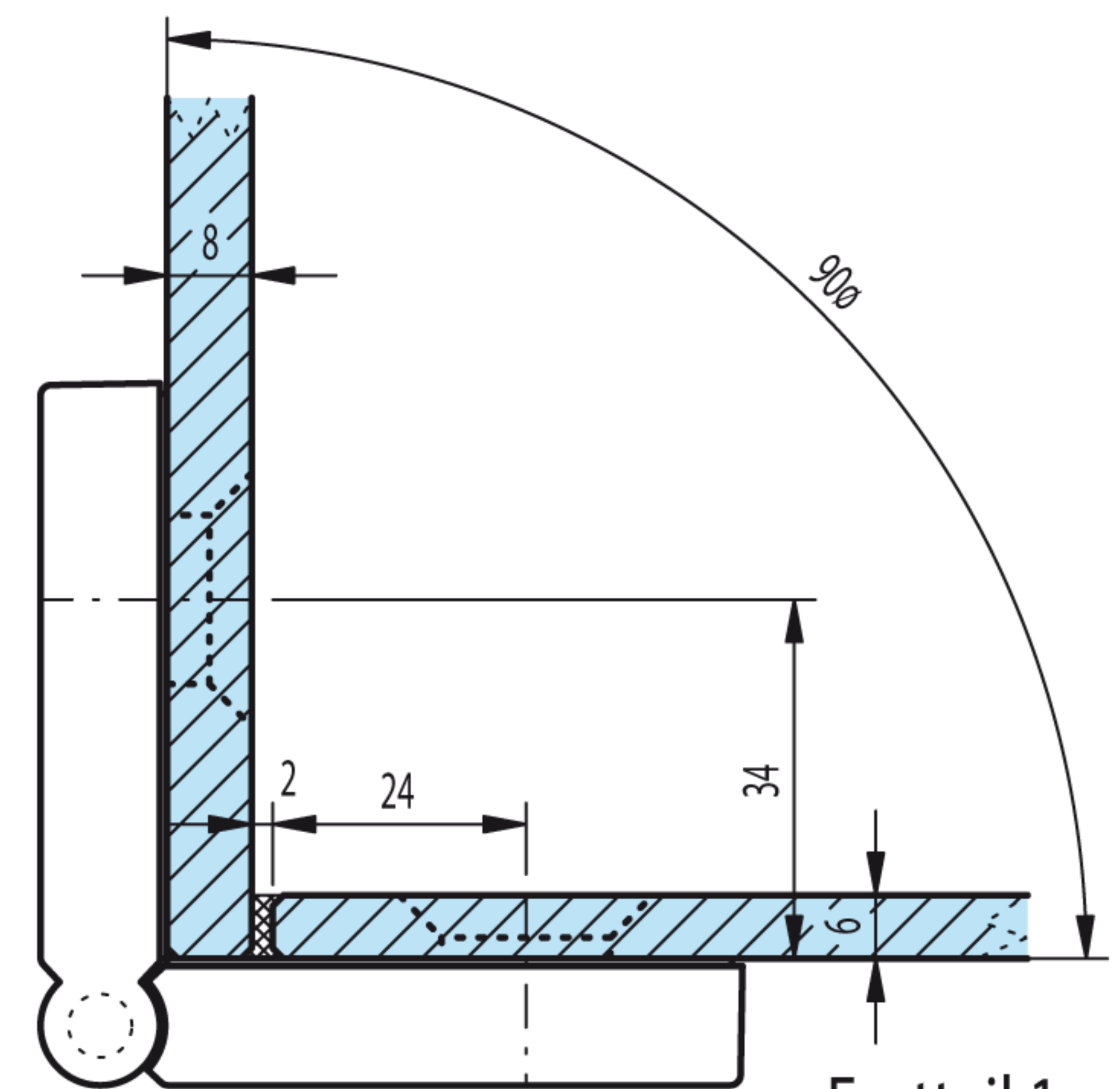

Festteil 1

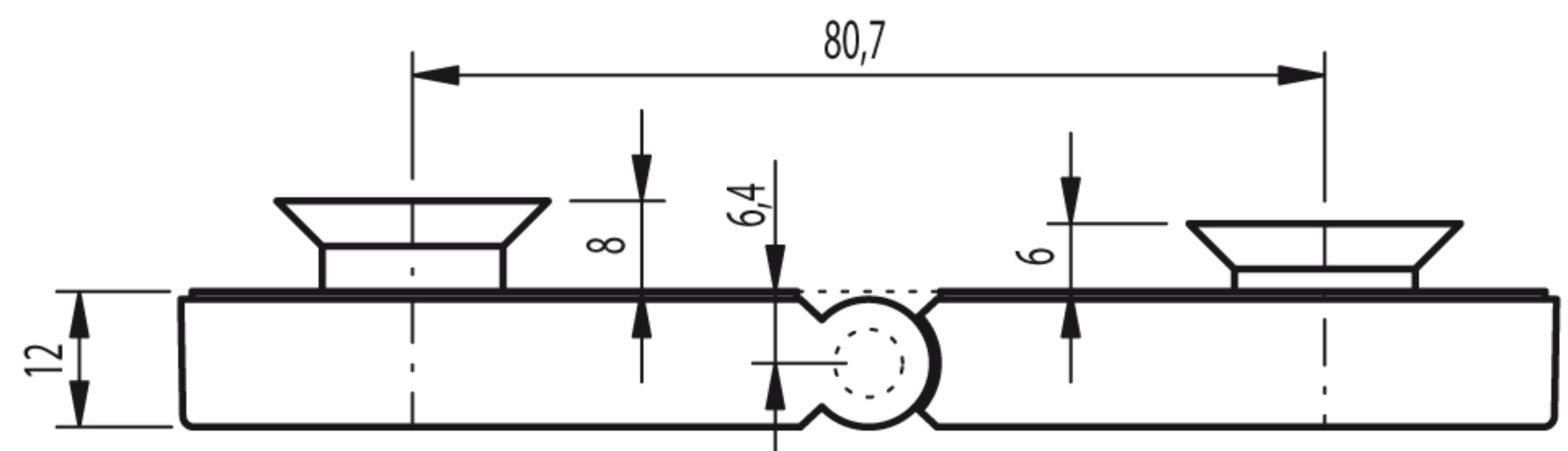
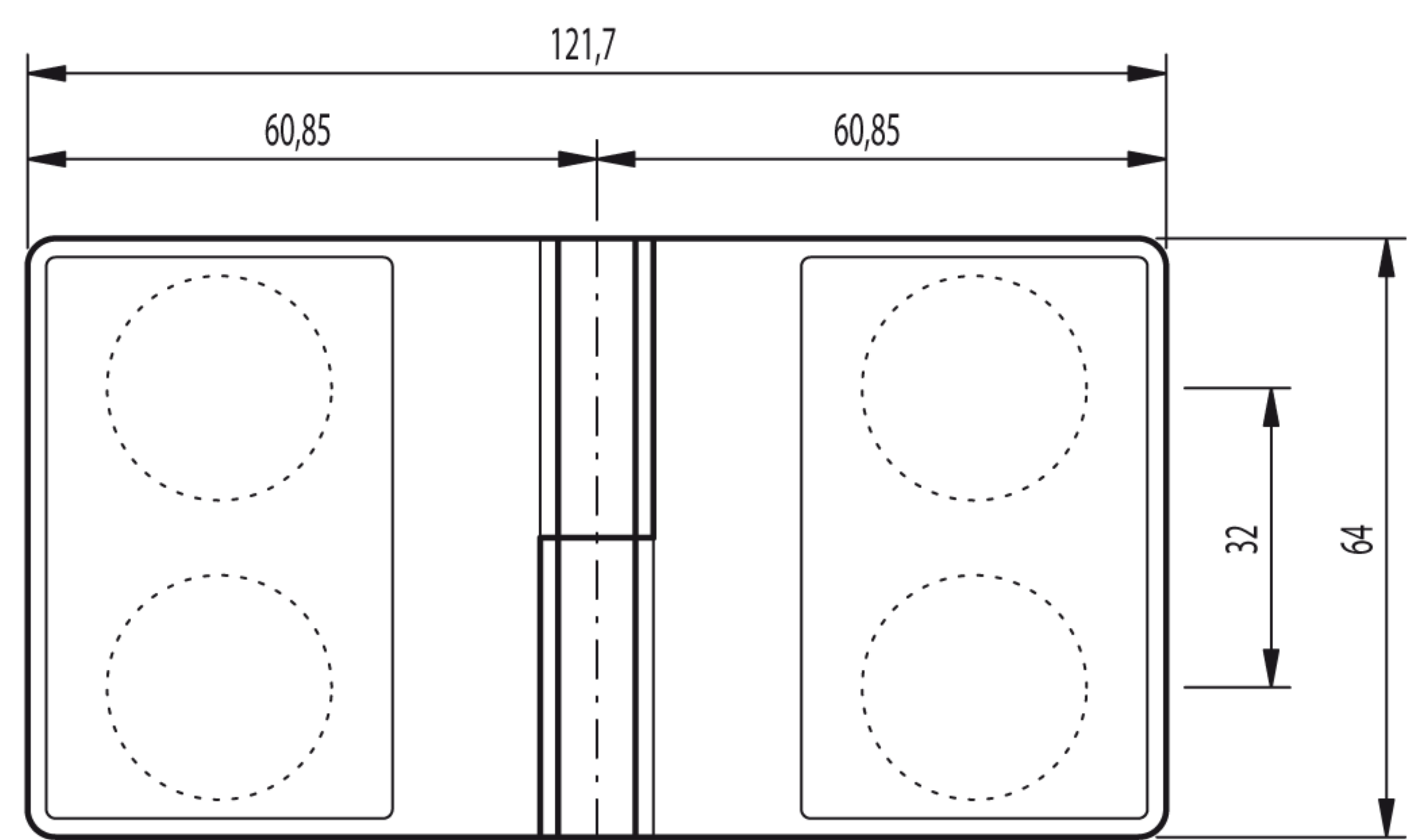

Art.-Nr.: 20 1056 12 XX 00