

Glasbearbeitung bei Verwendung als:

135ø Außenwinkel-Verbinder DIN "RECHTS", Glas 6 mit 8

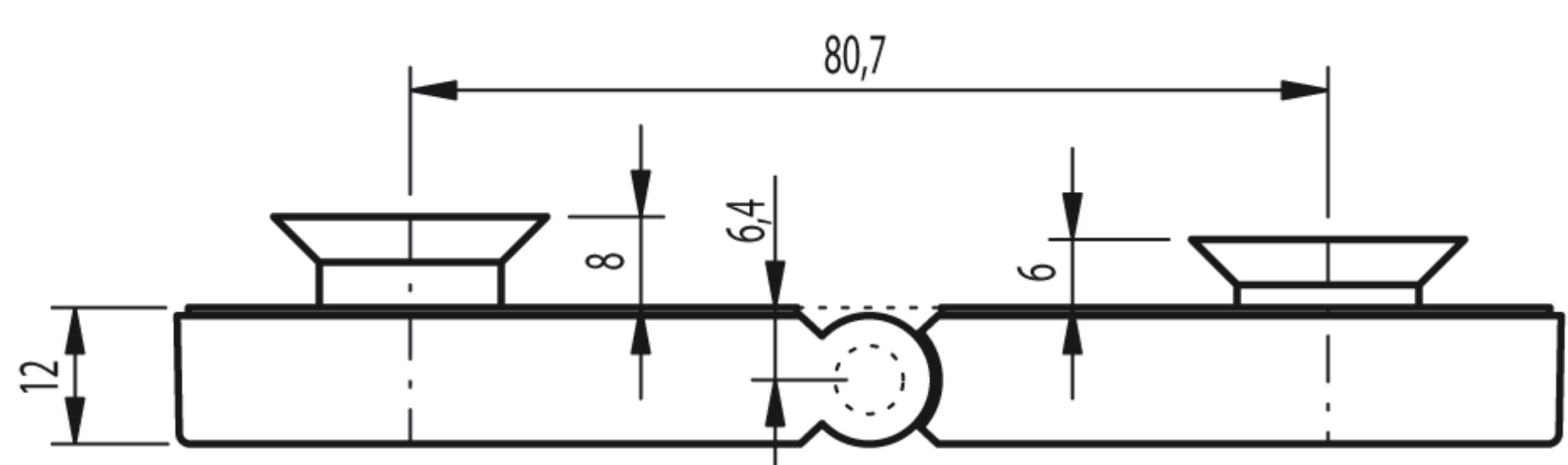

Art.-Nr.: 20 1056 12 XX 00

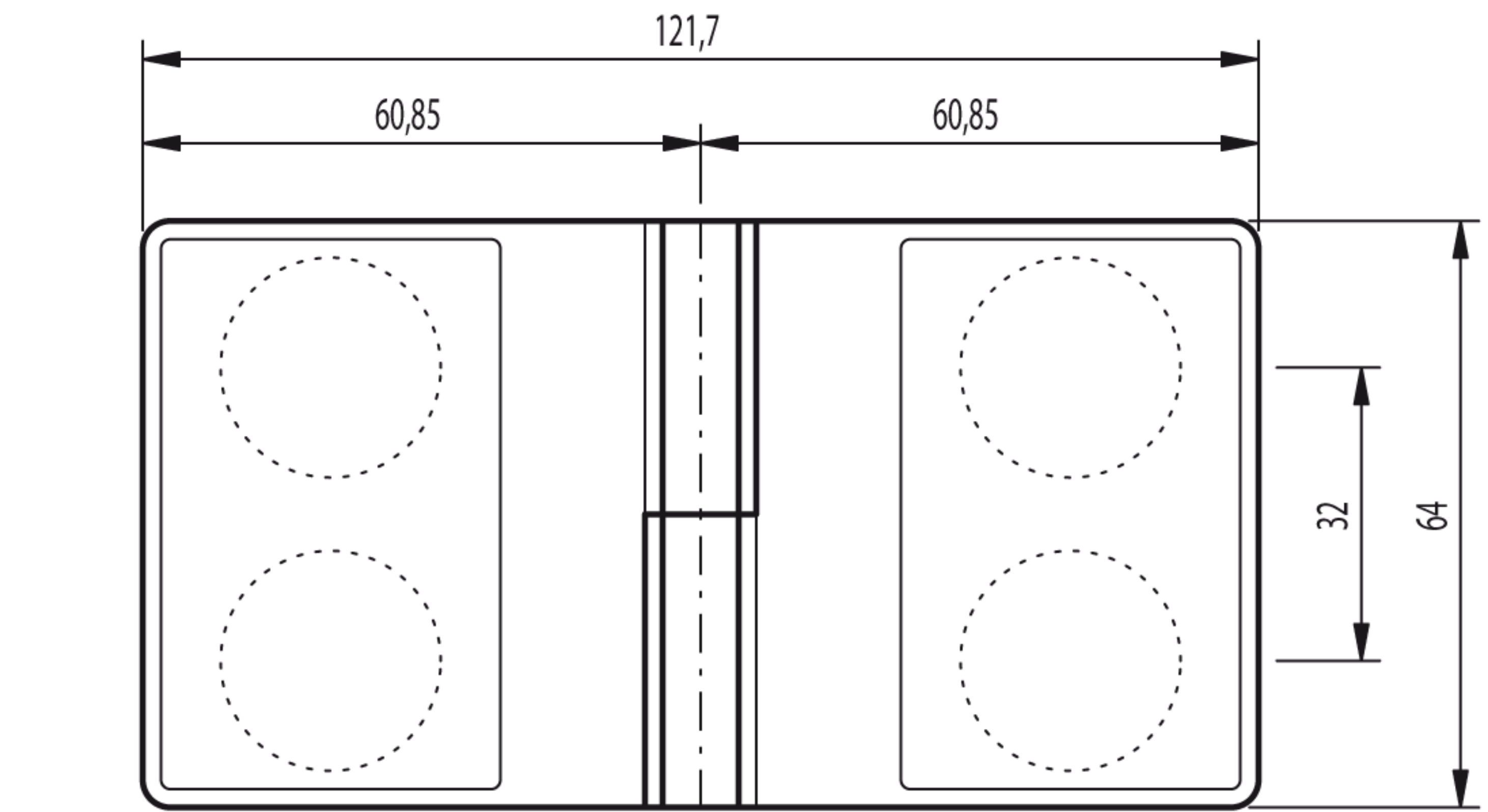
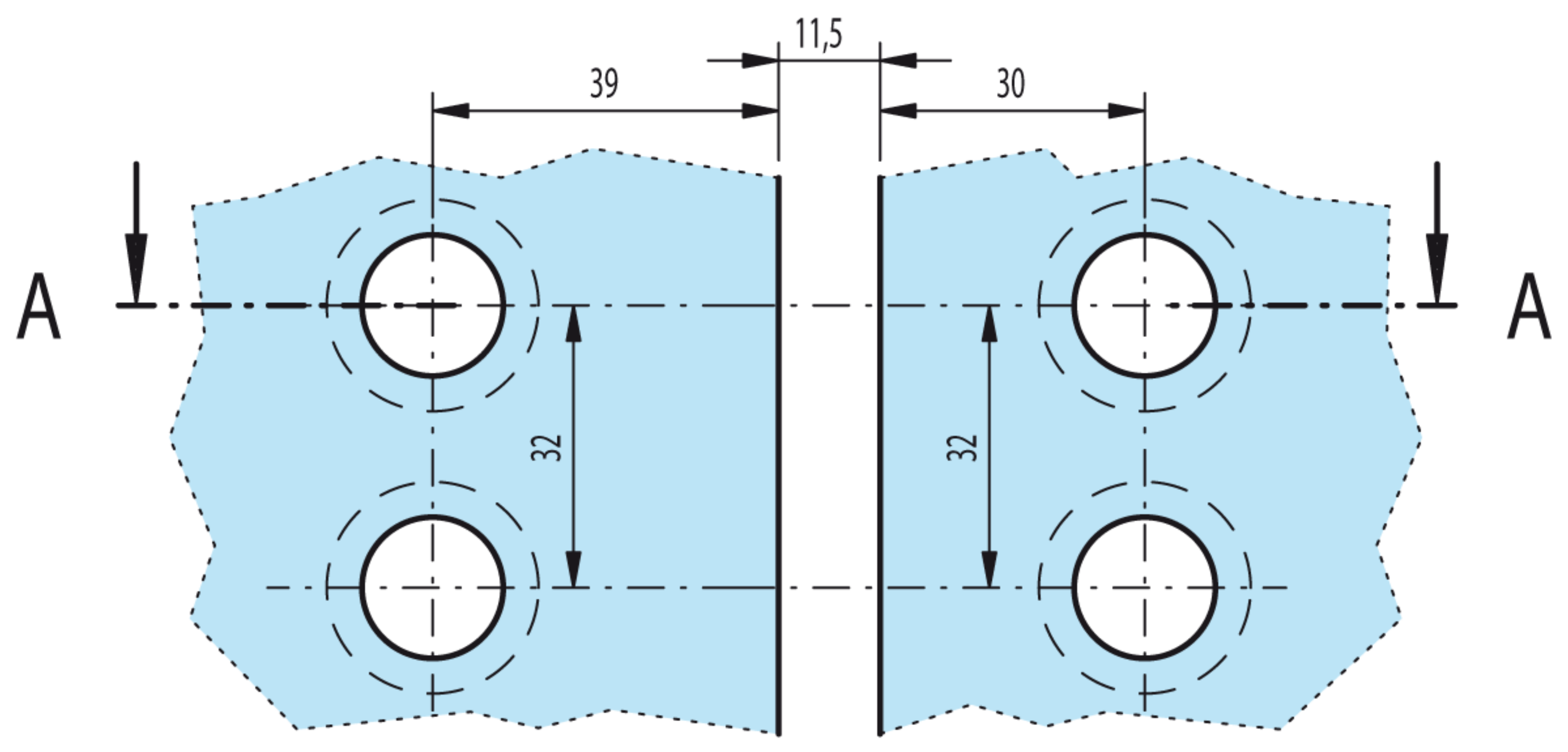

Festteilglas 2

Festteilglas 1

(Senkung = Innenseite)

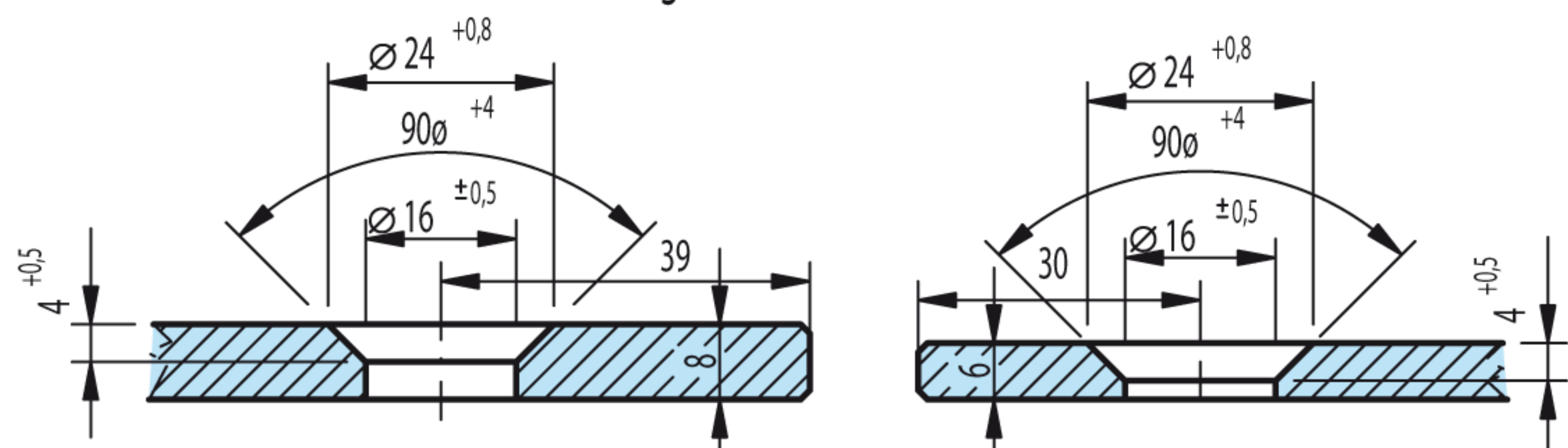

Schnitt: A-A (M1:1)

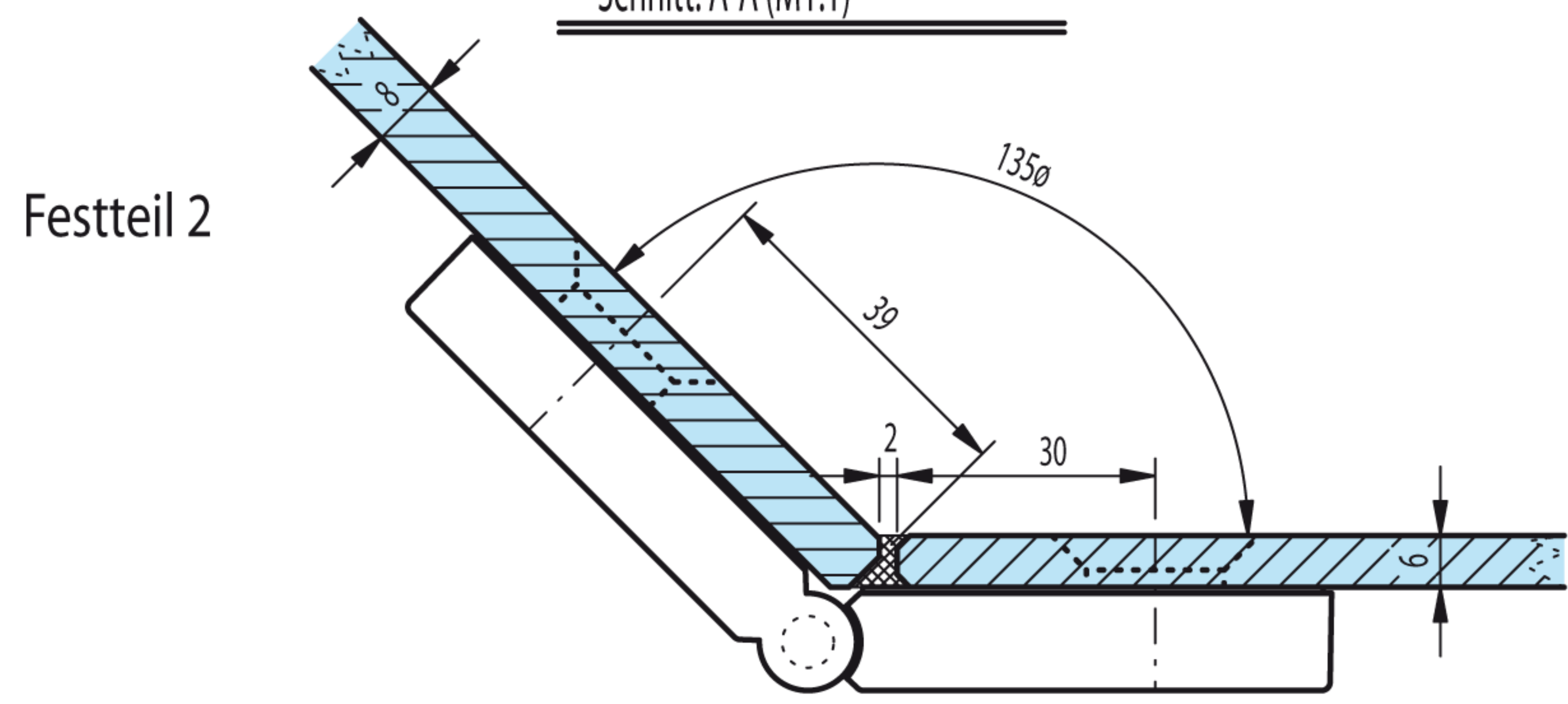

Festteil 2

Festteil 1