

Glasbearbeitung bei Verwendung als:

90° Außenwinkel-Verbinder DIN "LINKS", Glas 8 mit 6

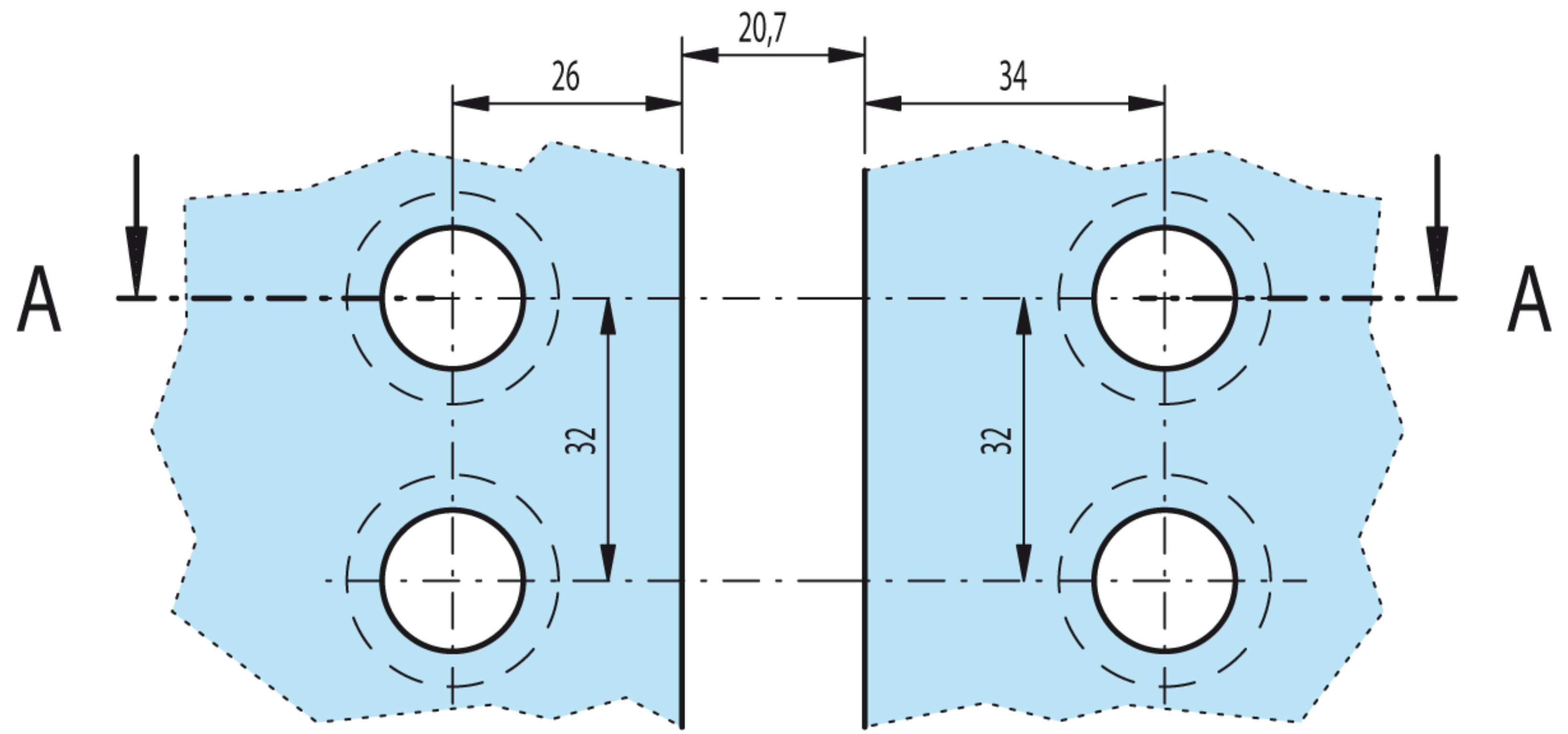

Festteilglas 1

Festteilglas 2

(Senkung = Innenseite)

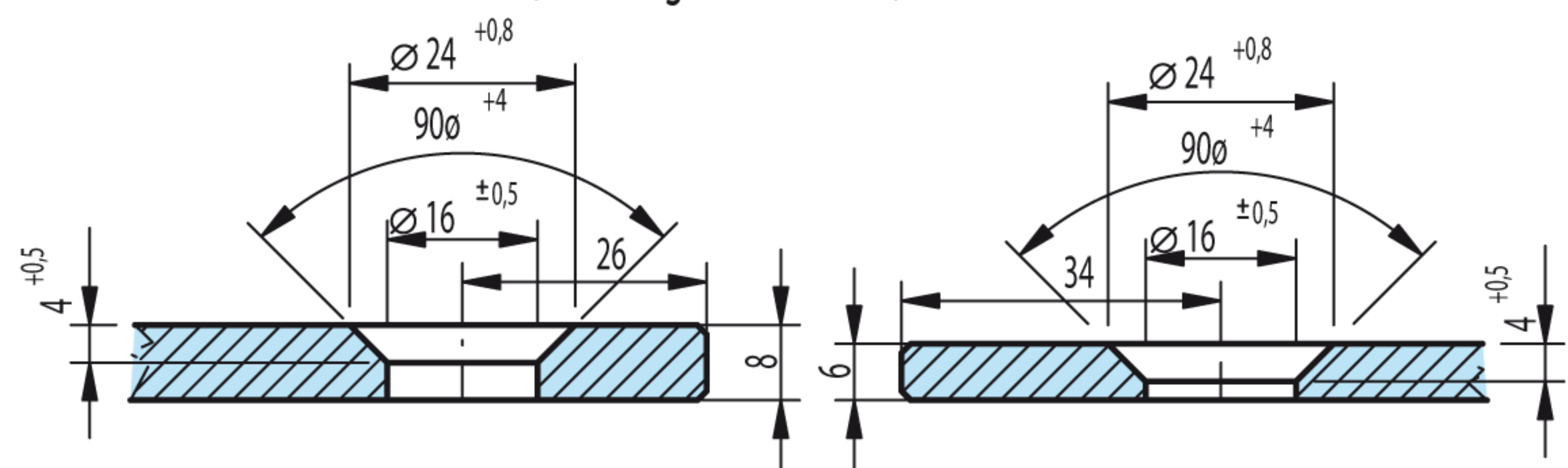

Schnitt: A-A (M1:1)

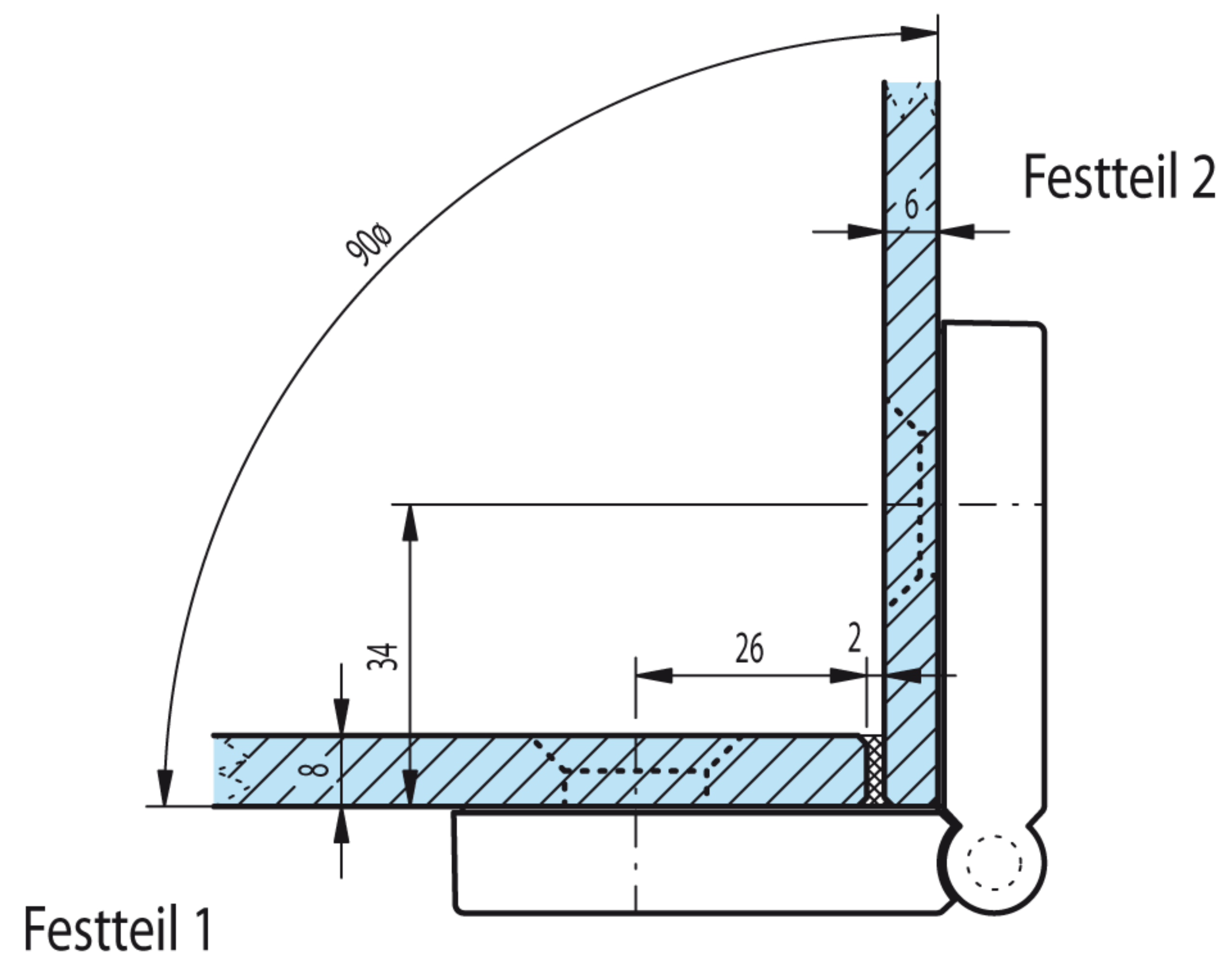

Festteil 1

Festteil 2

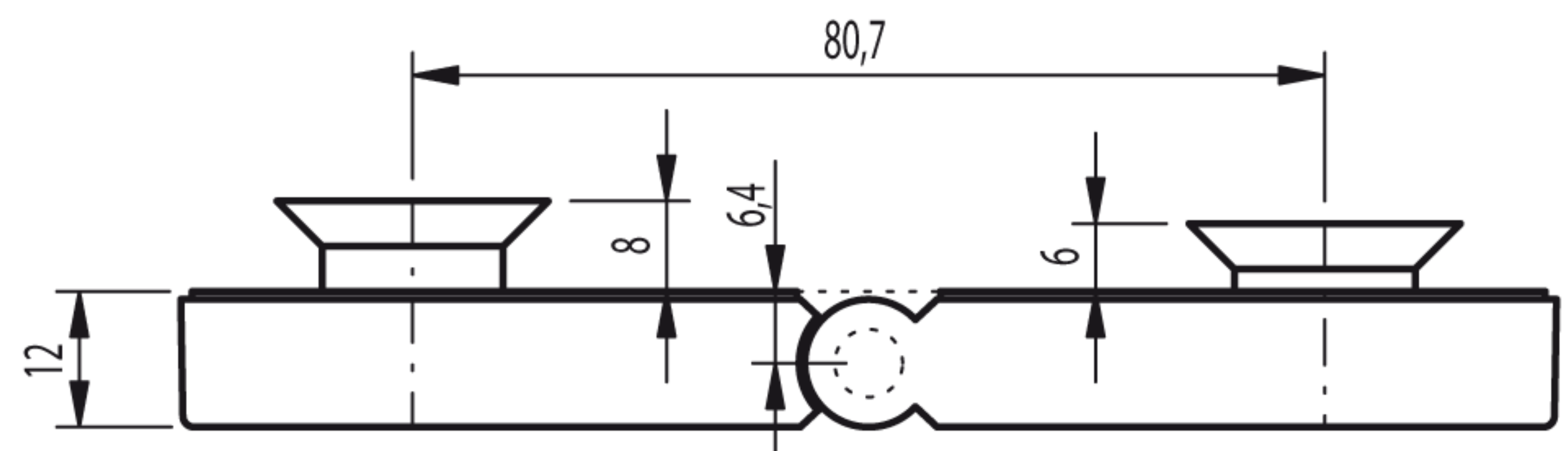
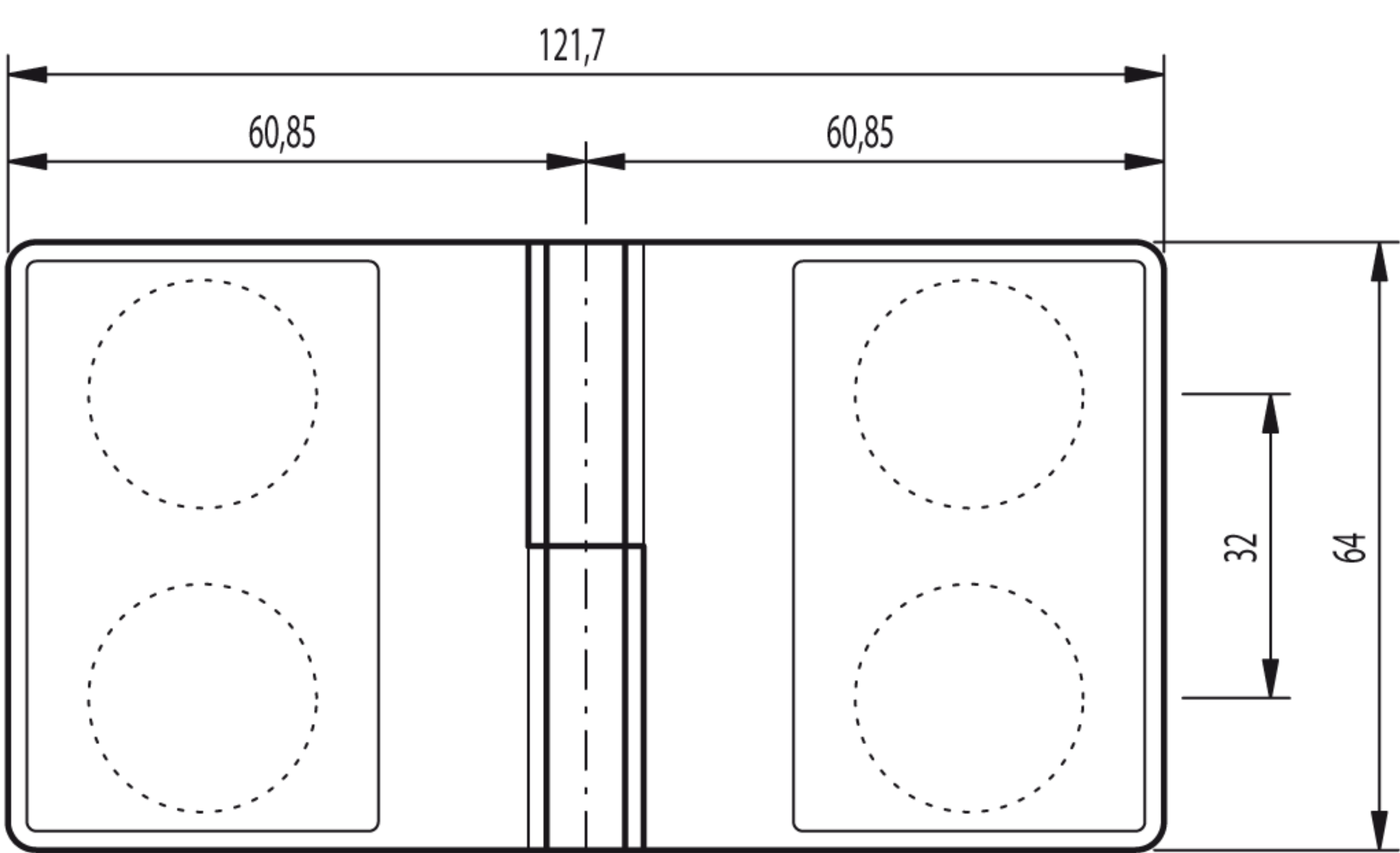

Art.-Nr.: 20 1055 12 XX 00