

Glasbearbeitung bei Verwendung von
Magnetdichtung Nr. 20 1168 11 27 01 / 20 1169 11 27 01

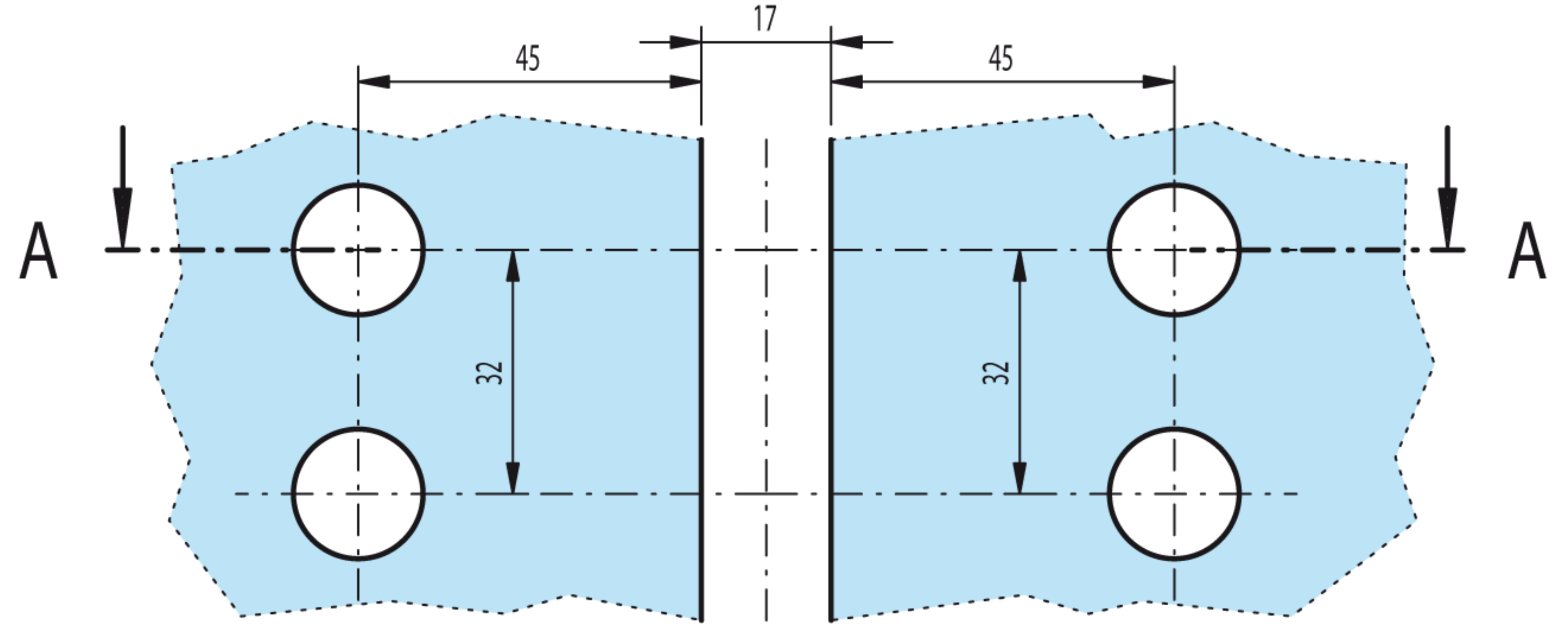

Flügelglas

Flügelglas

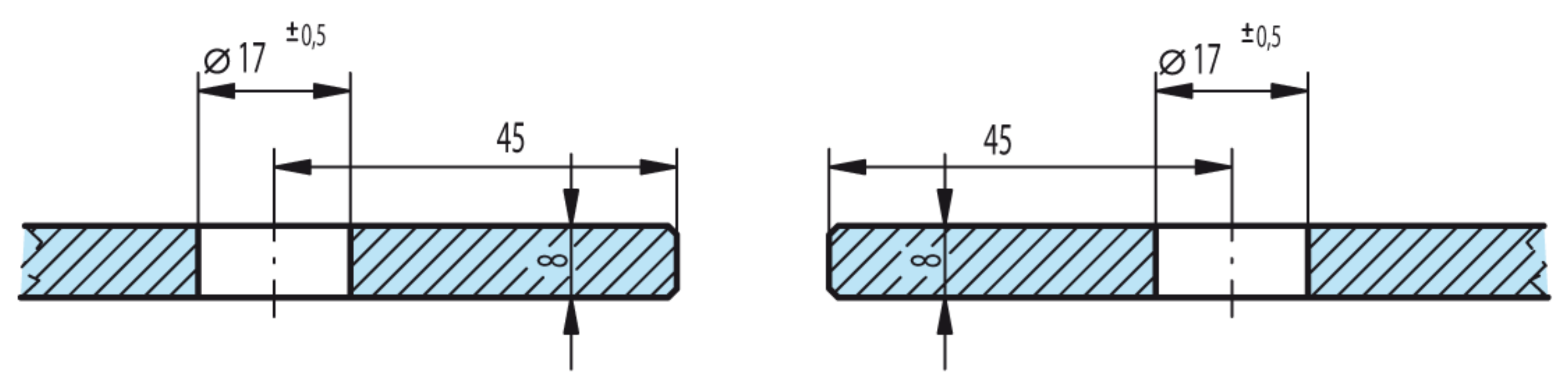

Schnitt: A-A (M1:1)

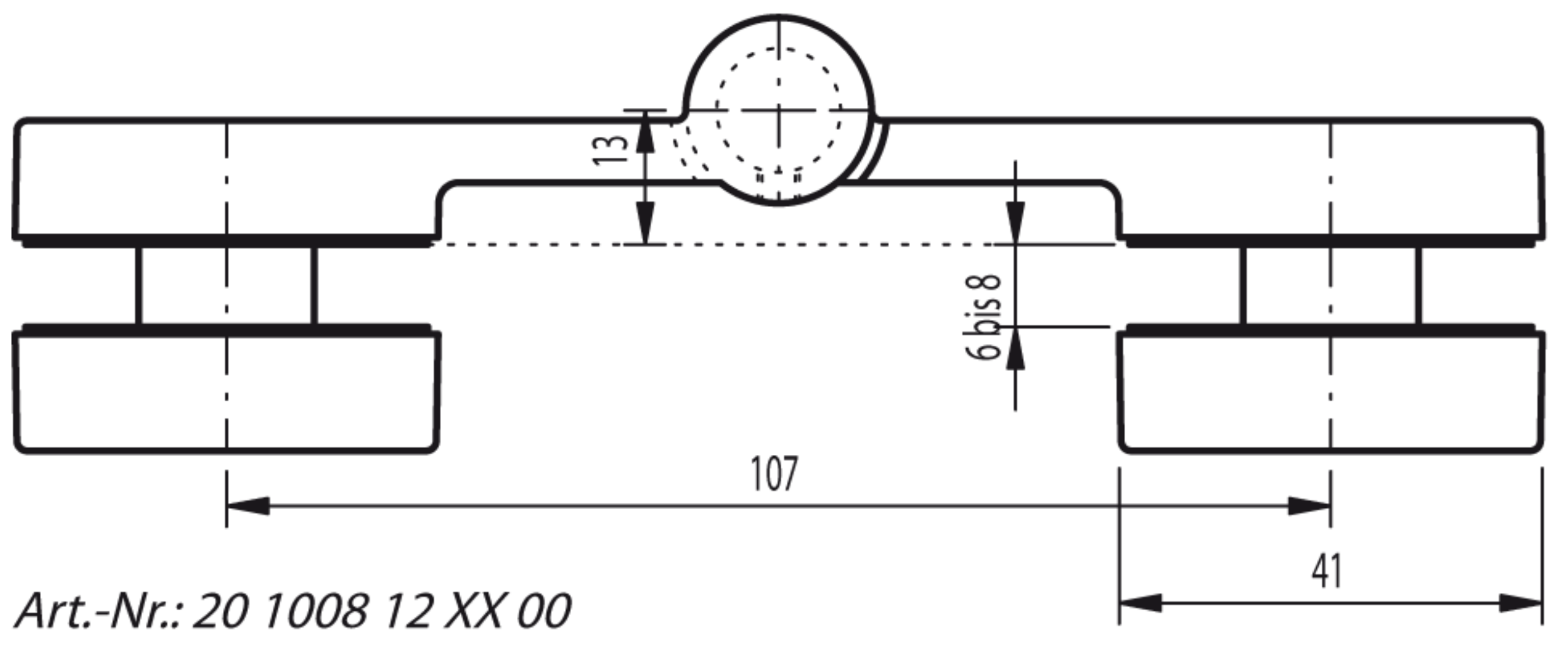
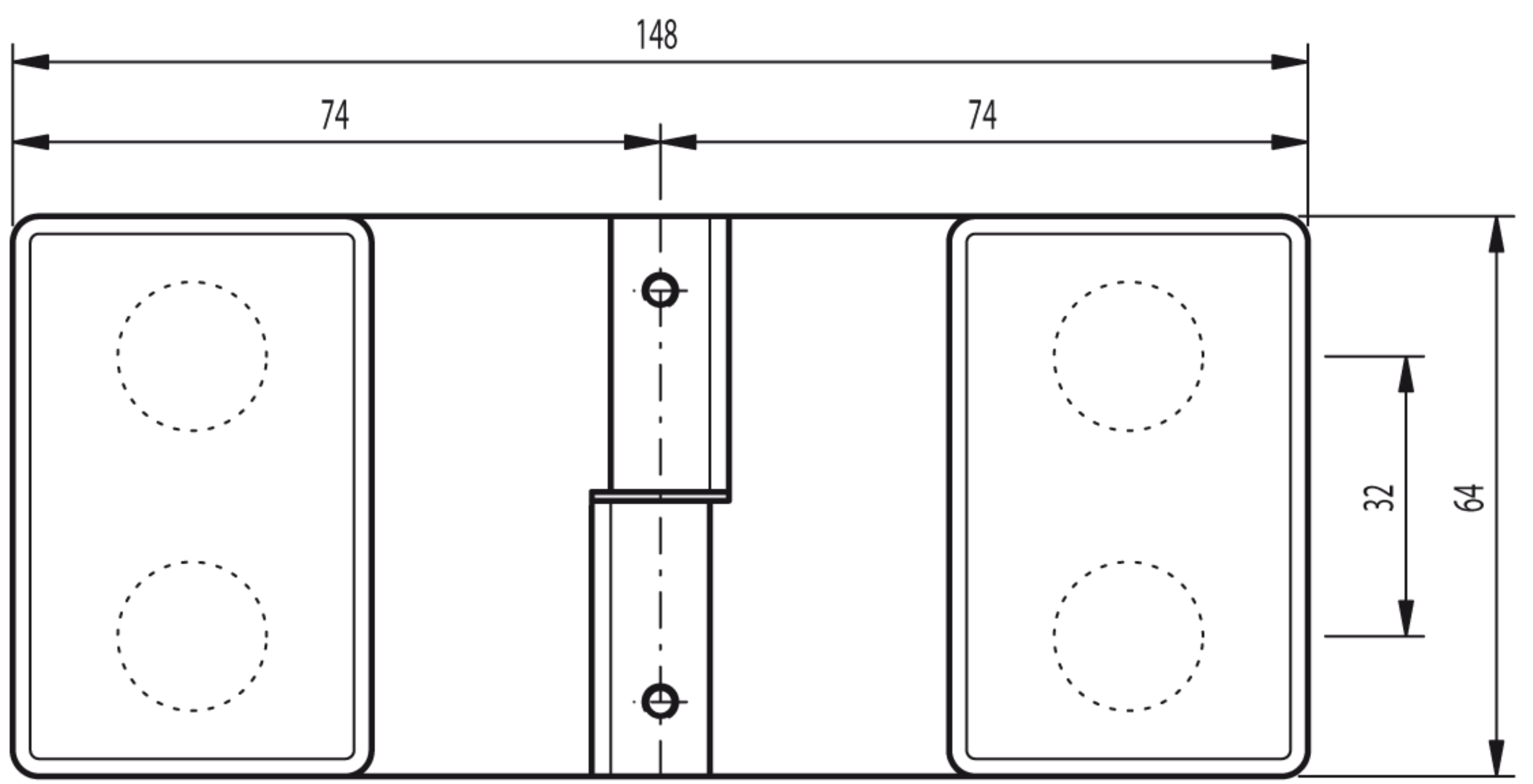

Art.-Nr.: 20 1008 12 XX 00

